

SDVD805

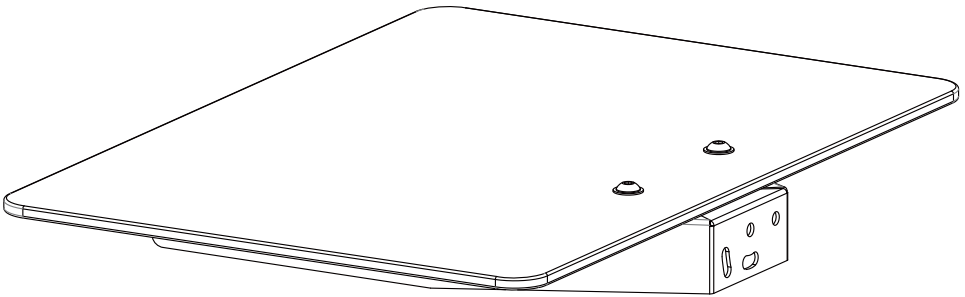

Peso Suportado

Ferramentas Recomendadas



Furadeira



Chave Phillips



Lápis

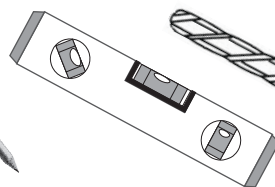

Nível

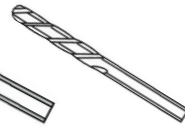

Ø8 mm
5/16"

Ø3.2 mm
1/8"

Kit da Parede

A. Buchas para concreto
Ø8 Ø5 L40



x 2

B. Parafusos soberbos
ST4.8 x L50



x 2

Kit de Ferramentas



Chave Allen

Passos de instalação

1. Remova os 2 parafusos sextavados usando a chave Allen e guarde-os

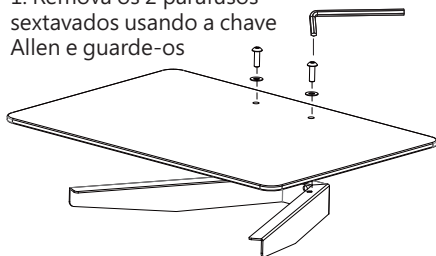

2. Marque o local do buraco para o suporte da parede

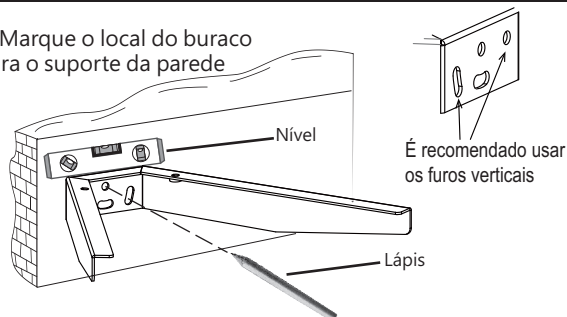

3. Faça os furos (x2)

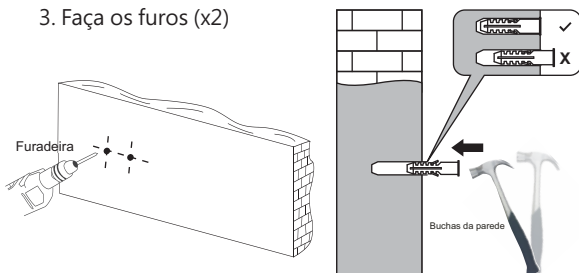

	Parede de madeira	Viga de madeira	Concreto
Tamanho do buraco	1/8" (3.2 mm)	1/8" (3.2 mm)	5/16" (8 mm)
Profundidade do buraco	Máximo	2.36" (60 mm)	2.36" (60 mm)

Faça os furos nos locais marcados (x2).

⚠ Só há necessidade do uso das buchas em paredes de concreto, não é necessário para paredes ou vigas de madeira

4. Prensando o suporte na parede com os parafusos soberbos

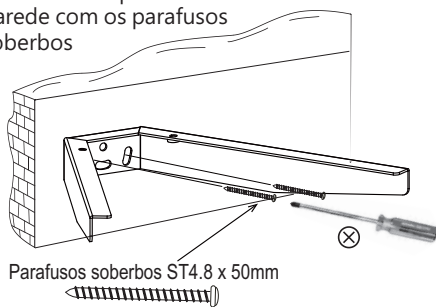

5. Insira o vidro no suporte

